



MAX 3500

USER MANUAL

CAUTION**WARNING: SHOCK HAZARD - DO NOT OPEN****AVIS: RISQUE DE CHOC ÉLECTRIQUE - NE PAS OUVRIR**

The lightning flash with arrowhead symbol, within an equilateral triangle, is intended to alert the user to the presence of uninsulated "dangerous voltage" within the product's enclosure that may be of sufficient magnitude to constitute a risk of electric shock to persons.



The exclamation point within an equilateral triangle is intended to alert the user to the presence of important operating and maintenance (servicing) instructions in the literature accompanying the appliance.

Important Safety Instructions

- 1) Read these instructions.
- 2) Keep these instructions.
- 3) Heed all warnings.
- 4) Follow all instructions.
- 5) Do not use this apparatus near water.
- 6) Clean only with dry cloth.
- 7) Do not block any ventilation openings. Install in accordance with the manufacturer's instructions.
- 8) Do not install near any heat sources such as radiators, heat registers, stoves, or other apparatus (including amplifiers) that produce heat.
- 9) Do not defeat the safety purpose of the polarized or grounding-type plug. A polarized plug has two blades with one wider than the other. A grounding type plug has two blades and a third grounding prong. The wide blade or the third prong are provided for your safety. If the provided plug does not fit into your outlet, consult an electrician for replacement of the obsolete outlet.
- 10) Protect the power cord from being walked on or pinched particularly at plugs, convenience receptacles, and the point where they exit from the apparatus.
- 11) Only use attachments/accessories specified by the manufacturer.
- 12) Use only with the cart, stand, tripod, bracket, or table specified by the manufacturer, or sold with the apparatus. When a cart is used, use caution when moving the cart/apparatus combination to avoid injury from tip-over.



- 13) Unplug this apparatus during lightning storms or when unused for long periods of time.
- 14) Refer all servicing to qualified service personnel. Servicing is required when the apparatus has been damaged in any way, such as power-supply cord or plug is damaged, liquid has been spilled or objects have fallen into the apparatus, the apparatus has been exposed to rain or moisture, does not operate normally, or has been dropped.

CAUTION

To prevent electric shock hazard, do not connect to mains power supply while grille is removed. minimum distances 10cm around the apparatus for sufficient ventilation; the ventilation should not be impeded by covering the ventilation openings with items, such as newspapers, table-cloths, curtains, etc.; no naked flame sources, such as lighted candles, should be placed on the apparatus; attention should be drawn to the environmental aspects of battery disposal; the use of apparatus in moderate climates. the apparatus shall not be exposed to dripping or splashing and that no objects filled with liquids, such as vases, shall be placed on the apparatus. Where the MAINS plug or an appliance coupler is used as the disconnect device, the disconnect device shall remain readily operable. Batteries (battery pack or batteries installed) shall not be exposed to excessive heat such as sunshine, fire or the like. "To reduce the risk of fire or electric shock, do not expose this apparatus to rain or moisture" Caution Marking and rating plate was located at rear enclosure of the apparatus.

CAUTION

Danger of explosion if battery is incorrectly replaced. Replace only with the same or equivalent type.

FCC warning:

Any Changes or modifications not expressly approved by the party responsible for compliance could void the user's authority to operate the equipment.

Note: This equipment has been tested and found to comply with the limits for a Class B digital device, pursuant to part 15 of the FCC Rules. These limits are designed to provide reasonable protection against harmful interference in a residential installation. This equipment generates uses and can radiate radio frequency energy and, if not installed and used in accordance with the instructions, may cause harmful interference to radio communications. However, there is no guarantee that interference will not occur in a particular installation. If this equipment does cause harmful interference to radio or television reception, which can be determined by turning the equipment off and on, the user is encouraged to try to correct the interference by one or more of the following measures:

- Reorient or relocate the receiving antenna.
- Increase the separation between the equipment and receiver.
- Connect the equipment into an outlet on a circuit different from that to which the receiver is connected.
- Consult the dealer or an experienced radio/TV technician for help.

This equipment complies with FCC radiation exposure limits set forth for an uncontrolled environment. This equipment should be installed and operated with minimum distance 20cm between the radiator & your body.

CAUTION

To reduce the risk of electric shock, do not remove the cover. Refer servicing to qualified service personnel. Please read the manual carefully before operating. Keep it in a safe place for future reference.

-This is a Class I Apparatus:

Apparatus with Class 1 construction must be connected to a mains socket with a protective earthing coating

USER INSTRUCTIONS FOR DVD PLAYER

Please Do Not:

- Put the player in sunshine, on or next to any radiation devices such as heaters, stoves or other appliances that produce heat.
- Put the player in badly ventilated, dusty or high moisture areas or in unsteady or vibrating areas.
- Expose the unit to rain or water.
- Play discs that are scratched or warped as they may damage the unit.

POWER SUPPLY

- The power supply required is AC 100-240V~, 50/60Hz.
- When not planning to use this unit for long periods of time, disconnect the AC power plug from the outlet.
- To prolong the life of this unit, the changeover period between switch-on and switch-off should not be less than ten seconds.

DVD PLAYER FEATURES

1. Fully compatible with DVD, VCD, MP3, CD-R and CD-RW with high error correction ability.
2. Reads picture CD to realize digital picture display.
3. 10 bit digital video converter, resolution is more than 500 lines.
4. 24bit/96KHz digital audio converter, high quality sound effects, professional Hi-Fi level.
5. Video component signal output, Composite video output, Optical, Coaxial HDMI and YUV output for selection.
6. Eight languages and 32 caption modes can be selected.
7. Various TV screen display selection and preferred story selection to view.

LASER HEAD OVER CURRENT PROTECTION SYSTEM

Laser head is the most important and critical part of the whole machine. Its performance is directly linked to the whole equipment's service life and error correction function. When a common player reads a scratched disc or a non-standard disc, the laser intensity will be 2-4 times or even up to 20 times the normal level, thus greatly reducing its service life. This appliance is provided with a unique laser head over current protection system, which will ensure constant laser current and thus greatly extend the service life of the laser head.

CONTROLS

FRONT PANEL

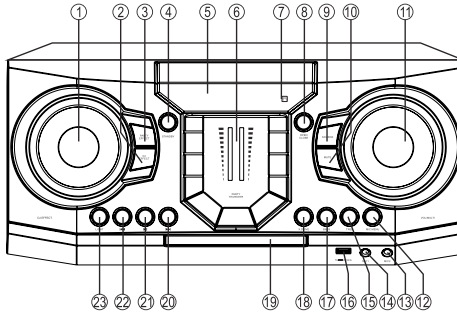

- | | |
|----------------------------|-----------------------|
| 1. DJ EFFECT knob | 13. MICROPHONE 2 JACK |
| 2. DJ EFFECT button | 14. MICROPHONE 1 JACK |
| 3. PARTY EFFECT button | 15. TREBLE |
| 4. STANDBY button | 16. FLASH DRIVE JACK |
| 5. LED DISPLAY | 17. BASS |
| 6. PARTY THURSTER | 18. X. DRIVE |
| 7. Remote control receiver | 19. COMPARTMENT DOOR |
| 8. OPEN/CLOSE button | 20. NEXT |
| 9. SOURCE button | 21. PLAY/PAUSE |
| 10. MUTE button | 22. PREVIOUS |
| 11. VOULME/MULTI | 23. LIGHT |
| 12. MIC MENU | |

REAR PANEL

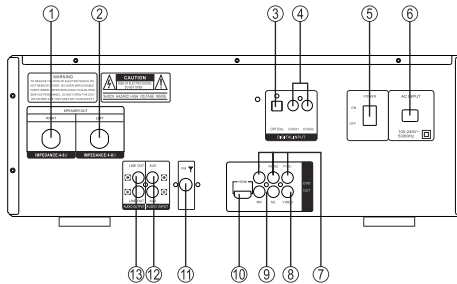

1. (RIGHT) SPEAKER OUTPUT JACK
2. (LEFT) SPEAKER OUTPUT JACK
3. OPTICAL DIGITAL INPUT
4. COAXIAL DIGITAL INPUT
5. POWER SWITCH
6. AC INPUT(100-240V~,50/60Hz)
7. COMPONENT(YUV) VIDEO OUTPUT JACK
8. VIDEO OUTPUT JACK
9. AUDIO OUTPUT JACK
10. DIGITAL SIGNAL OPTICAL OUTPUT
11. FM ANTENNA JACK
12. AUX AUDIO INPUT
13. LINE OUT OUTPUT JACK

REMOTE CONTROL

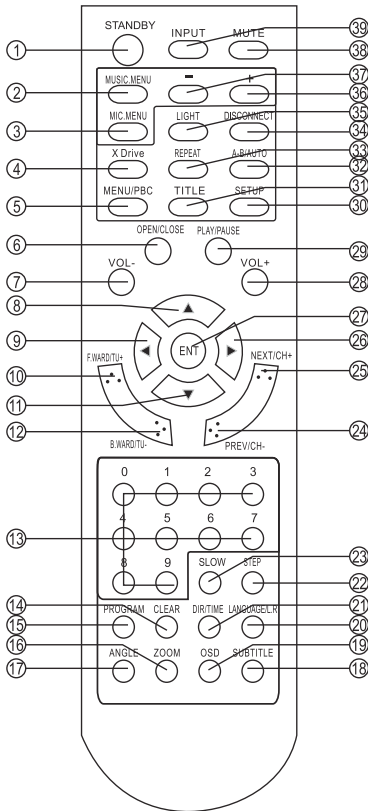

1. STANDBY
2. MUSIC MENU
3. MIC MENU
4. XDRIVE
5. MENU/PBC
6. OPEN/CLOSE
7. VOLUME-
8. UP
9. LEFT
10. F.WARD/TUNING+
11. DOWN
12. B.WARD/TUNING-
13. NUMBER BUTTON
14. CLEAR
15. PROGRAM
16. ZOOM
17. ANGLE
18. SUBTITLE
19. OSD
20. LANGUAGE/L.R
21. DIR/TIME
22. STEP
23. SLOW
24. PREVIOUS/CHANNEL-
25. NEXT/CHANNEL+
26. RIGHT
27. ENTER
28. VOLUME+
29. PLAY/PAUSE
30. SETUP
31. TITLE
32. A-B/AUTO
33. REPEAT
34. DISCONNECT
35. LIGHT
36. MIC/MUSIC.MENU ADJUST+
37. MIC/MUSIC.MENU ADJUST-
38. MUTE
39. INPUT

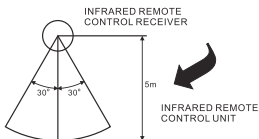

REMOTE CONTROL OPERATION:

- If the remote control conflicts with other devices, the operation will be affected.
- Do not simultaneously press buttons on the unit and the remote control.
- Avoid using two remote controls at the same time as this will cause a malfunction.
- Use only UM-4 "AAA" size batteries. Do not mix old batteries with new ones.
- If the batteries leak, clean thoroughly before replacing with new ones.
- Do not short two terminals of the batteries. Dispose of old batteries in a suitable place.

PREPARATION

Instal batteries in the remote control

Place two AAA batteries in the battery compartment. Ensure that the polarities are correct. There should be no large obstacles between the remote control and the main unit.

System connection

1. When connecting this unit and other components, be sure that the power is off on all the units.
2. Audio/Video cables are connected by matching the various colours. Fit cables firmly.
3. Scheme of connection illustration:

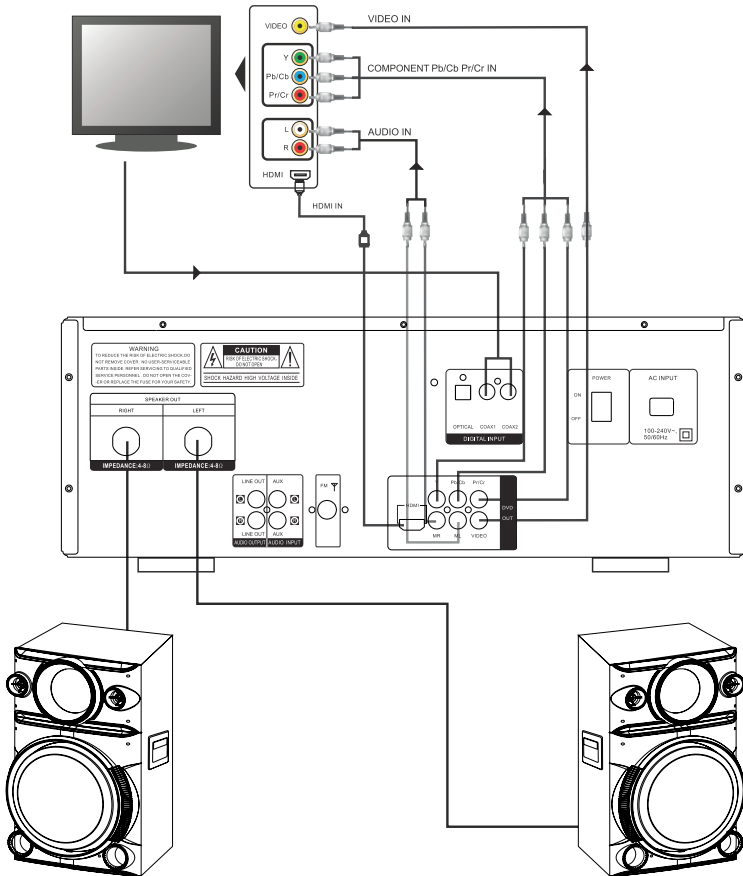

DVD BASIC OPERATION

Once all the connections and settings have been done, the DVD unit is ready for normal use. Prior to playback, make sure the following operations have been carried out.

1. Switch on TV and select AV mode.
2. Switch on this DVD unit.
3. Press the key SOURCE on the front panel or on the remote control, select DVD.

Step 1: Press POWER key, DISC LOADING shown on screen:



If there is no disc, NO DISC shown on screen:



Step 2: Press OPEN/CLOSE key, the tray comes out automatically.



Step 3: Place disc on the tray, press the key OPEN/CLOSE to close the tray, the disc type will be shown on the up-left corner of the screen as well as shown on LED screen.

Play disc

Once it's read the disc, this machine will start playing automatically.

If it is a DVD, the machine will show the DVD menu or title menu.

If it is a CD, this machine will start playing in the sequence.



Press PAUSE key:



Press PREV key:



Press NEXT key:



Press F.WARD key to get 2X, 4X, 8X, 16X, 32X, normal play circular fast forward function of DVD disc playing.

Press F.WARD key to get 2X, 4X, 8X, 16X, 32X, normal play circular fast forward function of other type of disc playing.



Press B.WARD key to get 2X, 4X, 8X, 16X, 32X, normal play circular fast reverse function of DVD disc playing.

Press B.WARD key to get 2X, 4X, 8X, 16X, 32X, normal play circular fast reverse function of other disc playing.



DVD DESCRIPTION OF FUNCTION

Subtitle

This DVD function may enable you to select multi subtitle languages (as many as 32 kinds and only for the disc with multi subtitle encoded). Press SUBTITLE key to get desired display. For example, to select language 2 English from 8 options.

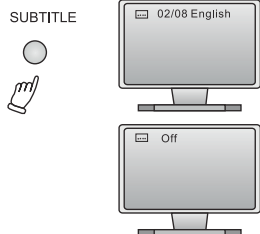

Title

Press TITLE key to get title menu. (This operation works only for the disc with multi title encoded).

Menu

Press MENU key to return to main menu for DVD disc playing.

Direction key

During playing discs, the four direction keys enable you to select at your option in title, menu or setup.

Number key

Press relevant number key for direct access according to picture titles.

Time

When playing a DVD, press TIME key. The following will be displayed:

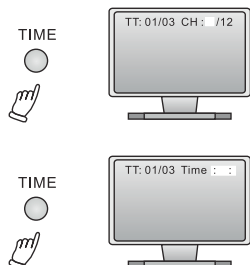

In the condition of SVCD, VCD disc in PBC OFF:

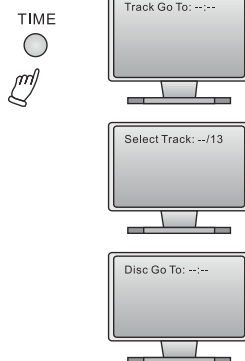

You may press the numbered buttons to enter the desired playing time. For example 55:50, stands for 55 minutes and 50 seconds.

PBC play

In the PBC ON mode, song selection can only be done from the main menu.

Repeat from A to B

First press of A-B key to set initial point (A):



Second press of A-B key, to set endpoint(B):



Repeat

In DVD mode, press REPEAT key. The following will be displayed:



Chapter repeat on



Title repeat on



Repeat all



Repeat off

In SVCD/VCD mode, press PBC key to get PBC off, then press REPEAT key. The following will be displayed:

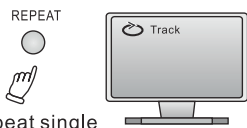

Repeat single



Repeat all

Zoom

The picture may be enlarged by up to 4 times to facilitate you to enjoy a particular action or still picture. Press this button 4 times, the zoom scales will be 2X,3X,4X,1/2,1/3,1/4,OFF respectively.

Angle

During a sport match, concert or theatrical program, press ANGLE key continually on remote controller to select various angles to view the same image (This operation works only for the disc with multi angle encoded).



System setup

TV system: for composite only

Based on TV hardware, select proper options:
NTSC, PAL or AUTO.
Default is NTSC.

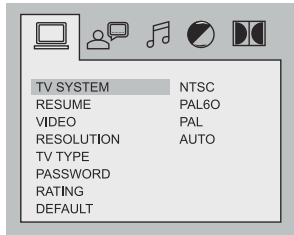

Screen Saver

Use this option to turn the screen saver ON or OFF

Resolution

On HDMI, select one of the following video output resolution: OFF, 720P, 1080I, 1080P.

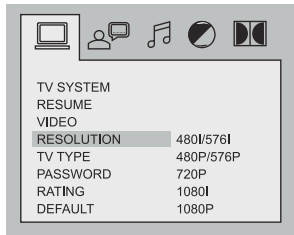

Video

Your video settings must correspond with the type of connection to your TV or other equipment.

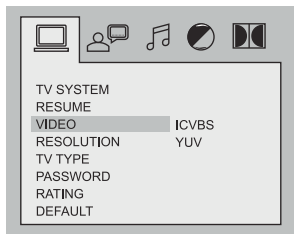





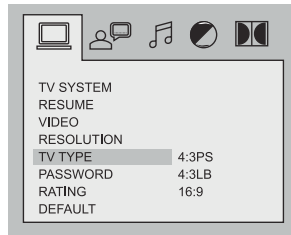



TV Type

Use this submenu to select the aspect ratio.



NOTE:

- Irrespective of what screen format you have selected, if your screen displays in 4:3, the picture will be shown in that format regardless.
- For DVDs, the screen format is convertible.
- If your screen displays in 4:3, when a DVD with 16:9 display format is played back, the picture will be flattened.

TV Screen/ Film Format	4/3			16:9
	Normal	Full View	Mailbox	Wide Screen
4:3				
16:9				

Default

Use this option to restore the default factory settings.

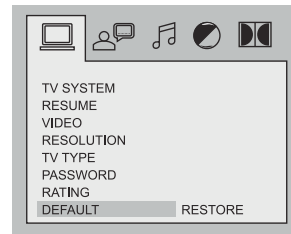

Resume

If this option is set to "ON" and the power is turned off, the player will remember where it stopped and when the power is resumed, it will continue to play from that point.

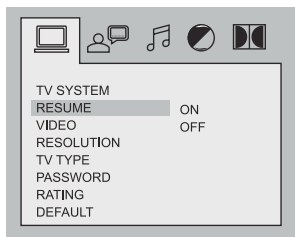

Language setup

Select options for your on-screen and menu language and subtitles.

OSD language

Select a language to be used on on-screen display and setup menu.



Audio language

Use this option to set the audio (dubbing) language.



Subtitle language

Use this option to set the subtitle language, or choose 'off' to hide the subtitles.

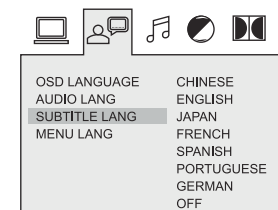

Menu language

Use this option to set the film's menu language.



Audio setup

Audio out

Use this menu to select your audio output.



Key

Use UP/DOWN arrows to adjust the key.

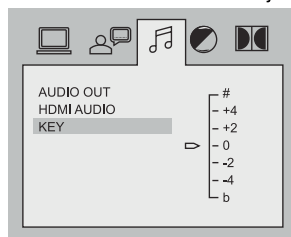

Video setup

Under this menu you can select options for your image output.

Brightness

Use UP/DOWN arrows to adjust the brightness.

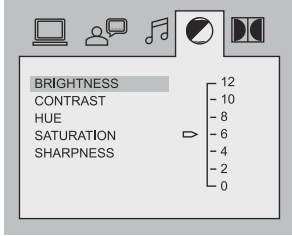

Sharpness

Use UP/DOWN arrows to adjust the sharpness.



Contrast

Use UP/DOWN arrows to adjust the contrast.



Digital setup

Use this menu to select digital setup options including dynamic range and dual/mono.

Dynamic range

When LINE OUT is selected, use this setting to adjust the line out ratio for a different effect. The audio signal peak value will be at the minimum when set to Full; peak value will be at the maximum when set to Off.

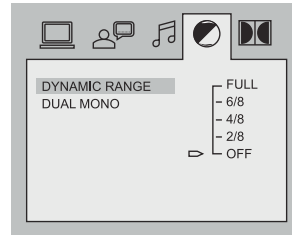

Hue

Use UP/DOWN arrows to adjust the hue.

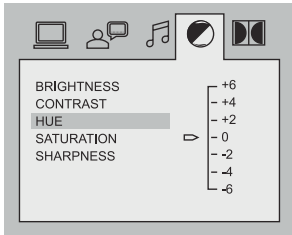

Dual mono

Choose this option to set up the left (L) and right (R) mono output; there are four modes in this option.

Saturation

Use UP/DOWN arrows to adjust the saturation.

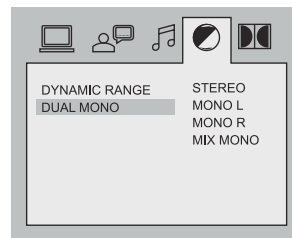
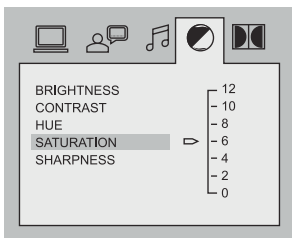

OPERATION OF MP3 FUNCTION

Mp3 is an audio compression mode using Level 3 of the international standard MPEG, whereby sound signal is compressed in a rate of 12:1. A Mp3 disc can record music for play of over 600 minutes or record over 170 songs, rivalrous CDs in sound quality.

To play a Mp3 disc

Select the track using numbered buttons

1. Follow the basic operating instructions to insert a Mp3 disc, this machine will start to search the information on the disc and show it in the display.
2. Press the number buttons to select the track number desired.
3. Press stop key then direction key to select other menu.

Repeat play

Using this function, the user will be able to enjoy a particular song or all the songs on the disc over and over again.

1. Choose a particular song to be repeated.
2. Press the REPEAT button, the Screen will display as illustrated.
3. Exit repeat play, the screen will display as illustrated.
4. Cancel the repeat function, folder will be on screen.

Others functions:

when a Mp3 disc is played, the features of mute, volume control, pause and forwards and backward search will also be available. The operations are the same with those of CDs.

JPEG

JPEG adopting the most efficient compression is widely used as picture storage type flattened and stored format.

Even if pictures are compressed 15-20 times. They still have good effect. Supported by most picture precessing software, fit for picture storage, it has small data and easy use. This machine can read JPEG format picture CD discs.

Press revelant number key to select picture display.

1. Put in disc correctly, the machine begins to search disc information.

2. Press number key to select picture.

3. It's efficient only in present picture when number key pressed.

Select to play by menu

1. Insert disc, machine searches disc information and main menu displays on screen. Press number key to select picture. Press play key to enter play mode.
2. Press direction key to select picture then press. Play key.
3. In condition of stop. press direction key to select other pictures.
4. In condition of stop. Select the first line file item on the right. Then press play key, to return to upper menu.

Disc protection

Protection

- a. When loading or removing the discs, always hold them by the centre and edge.
- b. Do not stick or write anything on the surface. Protect discs against any finger prints.

Cleaning

Wipe the discs from time to time using a soft cloth. Always wipe from the centre toward the edge.

Storage

- a. Never warp the discs. During non-use periods, store them in their cases, which should be kept vertically. Do not expose discs to high temperature, dampness or extremely low temperature, or else it may cause damage to the discs.
- b. Do not expose discs to direct sunlight.

OPERATING THE AMPLIFIER

Normal function

1. Be sure to switch off the power and to connect the outputs to corresponding input jacks.
2. Turn on the power and wait 3-4 seconds until the speaker functions are connected.
3. Select an audio source by pressing the INPUT key on the front panel or on the remote control to display FLASH DRIVE, WIRELESS CONNECTION, FM, AUX, DISC, OPTICAL, COA1, COA2.
4. Adjust the VOLUME knob on the front panel or the VOL+/- key on the remote control to adjust the setting of the main volume.
5. Press the MENU key on the front panel to display BASS, TRE, MICV, ECHO, XDRIVE(ON/OFF), SPEAKER LIGHT, then adjust the knob or press MENU adjust+/- to change music treble, bass and MIC effect.
6. Press the MUTE key on the remote control to mute, press it again to reset.
7. Press X Drive on the remote to turn on/off X-Bass effect.
8. Press the LIGHT button to display light mode, then press the VOLUME/MULTI knob to change the OFF, R, G, B, RG, RB, GB, RGB, AUTO, DEMO light mode.

Light color control function

To control the light modes coming from the speaker panels by "Speaker" menu or "light model" button on remote control

- R = red lights flash
- G = green lights flash
- B = blue lights flash
- RG = red and green lights flash
- RB = red and blue lights flash
- GB = green and blue lights flash
- RGB = red, green, and blue lights flash
- Auto = the various color combinations cycle through and flash.
- Demo = lights flash and change color as if they were responding to the beat of the music.

Tuner applications

1. Before using the radio functions, you must attach the supplied antenna. Adjust the antenna to obtain optimum reception. Press the INPUT key on the front panel (amplifier) or on the remote control, to select "FM" function.
2. Press the CH+/CH- key on the remote control to find radio bands that you have previously saved.
3. Press or hold the TU+/TU- key on the remote control to adjust the radio frequency manually.
4. Press the AUTO key on the remote control, the machine will scan radio channels from low-frequency to high-frequency by itself and memorize the channels one by one.

Karaoke functions

1. The machine can auto detect whether MIC1, MIC2 is inserted.
Please turn off the microphone volume and adjust the volume gradually after inserting the microphone.
2. Press MIC.MENU on the remote control to display MVOL, then press +/-, to change the microphone VOLUME.
3. Press MIC.MENU on the remote control to display ECHO, then press +/-, to change the microphone ECHO.

Note: Do not touch the top of the microphone when singing in order to avoid a howling effect.

Adjust the microphone volume gradually to avoid howling effect.

WIRELESS CONNECTION pair and connect

- Turn off any wireless devices previously paired (linked) with this unit.
- Turn on the wireless features on your phone or music player.
- Turn on and set this unit to wireless mode.
- Set your phone or music player to search for wireless devices.
- Select MAX3500 from search results on your phone or music player
- Select OK or YES to pair this unit with your phone or music player
- If protected, enter 0000 for passkey.

SOUND EFFECT

1. DJ EFFECT
Press DJ EFFECT button on the front panel, then turns the DJ EFFECT big knob to get the corresponding DJ effects, OFF, B.BOX, REVER, SCRATCH, YEAH, BRING IT, YEA, GEYA, LASER, MARVEL, USER, PROC, CLUB, COME ON.
2. PARTY EFFECT
Press "PARTY EFFECT" on the front panel can select PARTY effect, THRUST, ALARM, VECTOR, FIREWORK, RAINING.
Push the PARTY EFFECT rod, can get the corresponding PARTY EFFECT, when rod arrive the MAX position, can get the corresponding special PARTY EFFECT, When pull the rod back to OFF, PARTY EFFECT turn off.
The complete process is OFF--->PARTY EFFECT---> PARTYMAX

Troubleshooting Guide

Before taking your unit to an authorised service centre, check the following.

No sound:

- Make sure that there is a good connection between the player and other appliances such as the power amplifier or the TV.
- Make sure that you are operating the TV and the power amplifier correctly.

No picture:

- Make sure that there is a good connection between the player and other appliances such as the TV.
- Make sure the TV is switched on and the correct AV input is selected.

Disc does not play:

- Make sure the disc is loaded correctly (label side is facing up on the disc tray.)
- Make sure the disc is clean.

Remote control does not work:

- Remove any obstacles between the player and the remote control.
- Point the remote control at the remote control sensor.
- Check the batteries.

Picture dividing:

- Make sure the disc is clean and not scratched.
- If the player is controlled by a micro-computer and encounters problems, switch the power off, wait a few seconds and then switch it on again. If no error message is displayed, the player should work properly.

TECHNICAL SPECIFICATIONS

Type	Amplifier/DVD
Play mode	NTSC/PAL
Disc mode	DVD, DVD+R/RW, CD, CD-R/RW, HDCD, MP3, MPEG4
Video Characteristics	
Resolution	≥500 lines
Video S/N ratio	≥56dB
Audio Characteristics	
Total output power	3500W P.M.P.O.
FM frequency	87.5-108MHZ
Audio S/N ratio	≥86dB
Dynamic range	≥90dB
Distortion	<0.1% (Max)
D/A converter	192KHz/24bit
Output Characteristics	
Video output	Composite video, Component video (Y, Cb, Cr), HDMI
Audio output	ML/MR,Line out
Digital audio Input	Coaxial, Optical
Power voltage	AC 100-240V~, 50/60Hz
Power consumption	250W

ITEM:

TV Audio System

Brand: Alienpro

Model: MAX 3500

IMPORTER:

ALIEN PRO AUDIO, INC

ADD: 264 LANDIS AVE SUITE 103, CHULA VISTA, CA 91910. US

TAX ID: 82-1166305

PHONE: 619-941-2651

MADE IN CHINA